

# THE BOSS-175/300

**Heavy-Duty Floor Machine  
with Interchangeable Apron  
13", 15", 17", 19" and 21" Aprons**

Safety enhanced  
non-conductive dual  
triggers / eliminates  
shock potential

Precision balanced,  
heavy-duty 66-frame  
motor / for easier operation

Non-marking, fixed  
6" wheels / for easy  
transport

Triple-planetary high torque  
transmission / handles  
the most demanding  
applications

175 / 300 RPM dual speed /  
versatility of two 1.5 HP  
machines in one

All metal chassis /  
added weight for  
faster results

Safety enhanced interlock  
switch / both hands are  
conveniently in control

Fully adjustable handle  
position / comfortable for  
all operators

Motor plugs in at  
handle base /  
for easy  
maintenance

Complete a  
range of  
floor care jobs  
with 5 aprons  
on 1 powerful  
machine

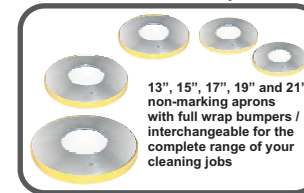

D/C rectified motor /  
eliminates brown-outs,  
low voltage and  
startup torque problems

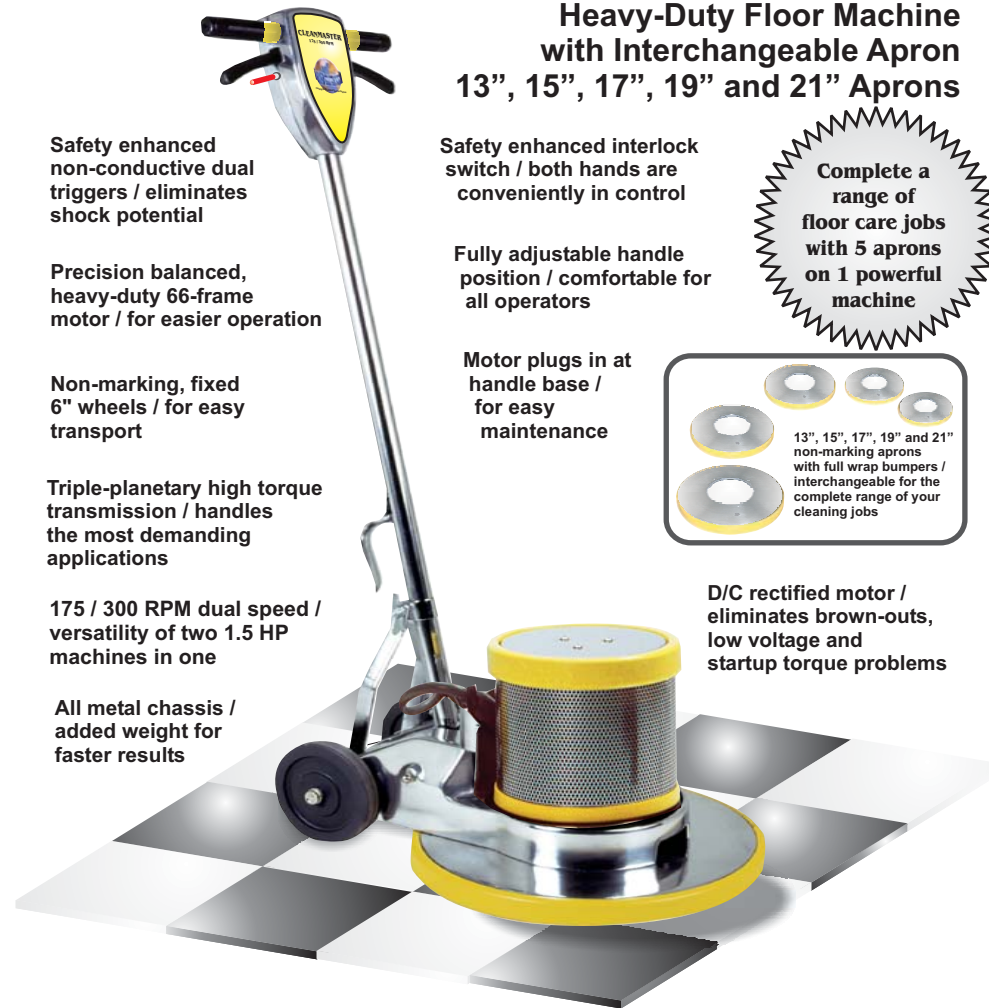

## SPECIFICATIONS

Model Number	BOSS-175/300				
Brush Speed	175 / 300 RPM Dual Speed				
Motor Type	1.5 HP D/C Rectified				
Amp Draw	13-15 amps				
Interchangeable Apron	13"	15"	17"	19"	21"
Part Number	A-173	A-167	A-169	A-171	A-172
Chassis	Polished aluminum				
Power Cord	50 foot safety yellow 14/3 Ga.				
Weight	95 - 98 lbs. (Depending on apron selection)				
Brush Drive	"B" style clutch				
Wheels	6" non-marking				
Warranty	5 years motor and gearbox				

# 1.0 Safe Operating Conditions

READ THIS MANUAL BEFORE USING THIS FLOOR MACHINE. KNOW THE PROPER OPERATION, CORRECT APPLICATIONS AND THE LIMITATIONS OF THIS EQUIPMENT **BEFORE** USE.

## Reduce the risk of fire, electric shock, or injury:

- This floor machine is designed for indoor use only. Do not use outdoors. Do not expose to rain.
- Do not wash motor with flowing water. If motor gets wet, seek authorized service.
- Keep the vents on this air-cooled motor free of debris. Do not operate with the motor covered or with vents blocks.



- Never operate this floor machine near flammable dusts, liquids or vapors. Never use flammable solvents as a cleaning agent. Engine sparks and operating heat can cause a fire.
- Never handle electrical equipment with wet hands. Never operate this floor machine in bare feet.



- Unplug the floor machine when not in use and when servicing the equipment. To unplug, grasp the plug, not the cord.
- Do not operate a floor machine with damaged handle controls, cord, or plug. If the equipment is not performing properly, seek repair from a qualified service supplier.

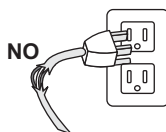

- This floor machine is constructed with electrical grounding at the plug. Operate only when connected to a properly grounded outlet. See section 1.2 for grounding details.

- Prevent electrical cord abuse. Do not close a door upon the cord, drive equipment over it, or run the floor machine over it. Do not exposing the cord to hot surfaces. Do not lift, pull or carry this floor machine by the cord.

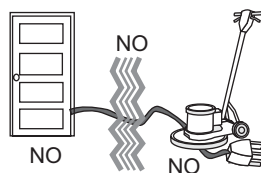

- Never operate the floor machine over sharp objects that can be thrown out and harm the operator and damage the floor. Sweep before scrubbing or buffing.

- Train your staff in the proper use of this floor machine.

# 1.1 Electric Power

This floor machine operates on a 15 amp nominal 120V, 60 hz, A.C. power circuit. The amp, hertz, and voltage ratings are listed on the motor spec label found on each machine. Using voltages above or below those indicated on the data label will damage the motor.



# 1.2 Grounding Instruction

This floor machine must be grounded while in use to protect the operator from electrical shock. This floor machine is equipped with a 3-wire cord and a 3-prong grounding type plug (Figure 1) to fit the properly grounded receptacle.

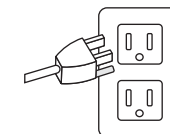

Figure 1

Before using this floor machine, make sure a properly grounded, 3-hole electrical outlet is available. If not, as in some older facilities, use an adapter for connecting a 3-prong plug to a 2-prong receptacle (Figure 2).

**IMPORTANT!!** This adaptor may not be used in Canada.

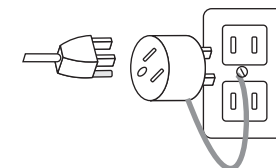

Figure 2

**IMPORTANT!!** Never cut off the grounding prong for use in a 2-prong outlet. By doing so, you have cut off your protection from electrical shock.

**Never assume that all 3-hole outlets are properly grounded.** Check the outlet with a **ground fault interrupter device** which quickly indicates if a ground is connected. Correct a faulty grounding before proceeding.

# 1.3 Extension Cords

This floor machine is shipped with a 50 foot (15 M) cord which plugs directly into an approved outlet. The use of an extension cord is not recommended.

## 2.0 Install the Handle

This machine handle (1) has been custom fit to its mounting yoke (2) at the factory and then taken apart for shipping. For easy assembly, make sure that the handle number on the tag (see right) matches the serial number stamped on the chassis.

This floor machine is shipped from the factory with the handle unattached. You will need two 7/16" wrench to complete the assembly.

1. Remove the handle and mounting hardware from carton. Bolts, nuts, washers and the locking lever assembly are in the plastic bag attached to the handle.
2. Slide the handle tube (1) over the mounting yoke (2). Push the tube down until the bolt holes are lined up.
3. Insert the mounting bolts (3) into the bolt holes **from the back of the machine**. Secure each bolt with a locking nut (4). The locking nuts (4) will be closest to the motor.
4. The handle mounting collar (5) is designed to slide freely up and down the handle tube. This feature allows the handle to be adjusted for the comfortable operation of all users. Align the mounting collar (5) and the two bent handle braces (6).
5. Take the lever assembly from the bag.
  - Place the curved spacer (8) with a square hole onto the locking lever shaft (7). The curve must face the lever.
  - Insert the shaft through the mounting hole in the left handle brace, mounting collar, and right handle brace.
  - Place a spacer (9) on the shaft.
  - Place the split washer (10) on the shaft.
  - Place the locking wing nut (11) on the shaft.
  - Adjust the wing nut for tightness.

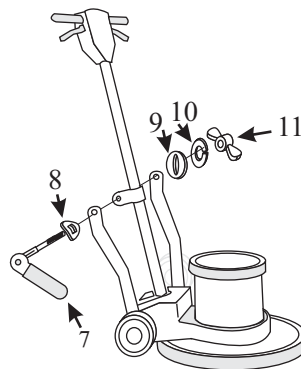
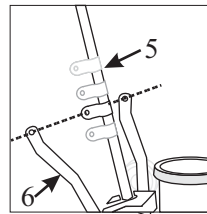
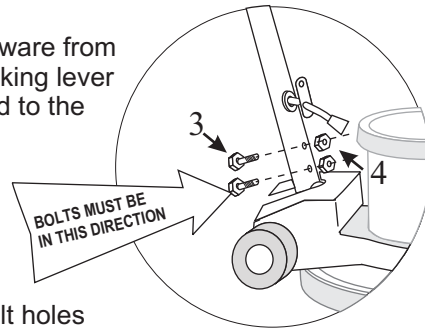
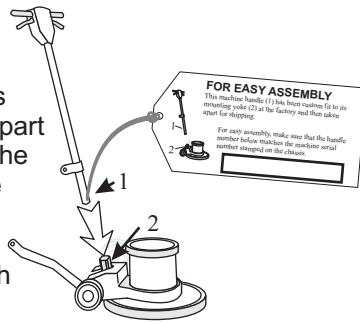

## 2.1 Install the apron

If you've purchased more than one apron, you can easily change aprons for different cleaning jobs.

- Lock the handle in the up position and tip the floor machine back.
- Give the brush a quick flip to unlock and remove the brush.
- Remove the 3 knurled thumb nuts that hold the apron to the machine chassis.
- Remove the existing apron.
- Align the new apron.
- Re-install the three bolts and tighten.
- Install a brush that is 2" smaller than the apron.

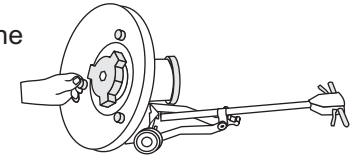

## 2.2 Attach the Power Cord

The triple-wire grounded power cord has been factory-installed into the handle tube. Plug the male connector (9) coming out of the motor housing into the female connector (10) coming out of the end of the handle tube.

Plug the end of the 50 foot power cord into a grounded power outlet. Unlock the handle and adjust the height for your comfort. Lock into place. Slide the red safety interlock switch forward and squeeze the triggers on the handle to check for power to the motor.

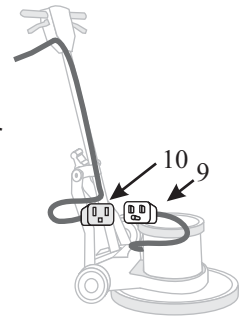

## 2.3 Install the Brush or Pad Driver

Your floor machine has been built with a "B" style drive plug fixed to the motor shaft. A brush or pad driver mounts onto the machine using a "B" style or a "Universal" clutch plate on the brush block

- Unplug the floor machine. Lock the machine handle in the "up" position and tip the floor machine back onto the handle.
- Mount the brush or pad driver with the clutch plate (11) over the drive plug (12).
- Give the brush a quick spin to lock the brush onto the floor machine.
- Now, lower the machine back onto the brush. You're ready to go to work.

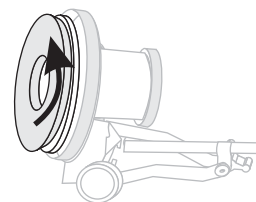
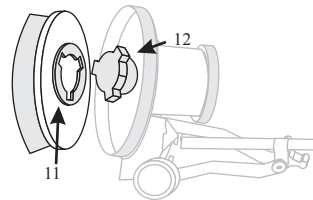
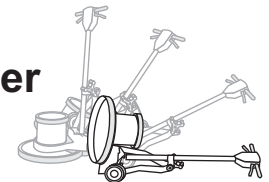

## 3.0 Operating Tips

- For indoor use only.
  - Sweep abrasive soils before scrubbing.
  - While the brush or pad driver is spinning, keep the floor machine moving to avoid “donut” burns on the floor.
  - To start operation:
    - Unlock the handle by raising the locking lever.
    - Lower the handle to a comfortable position, typically waist height.
    - Relock the handle by pushing the lever down.
- NEVER OPERATE THE MACHINE WITH THE HANDLE UNLOCKED.**
- This floor machine has a high torque motor. Hold the machine firmly with both hands when starting up.
  - Push the red safety interlock switch forward to unlock the dual triggers.
  - Squeeze the dual triggers to release power to the motor. Once power is on, either trigger will keep power to the motor.
  - To stop the floor machine, release both triggers.
  - The spinning brush helps move the floor machine. Lift the handle slightly to work to the right. Push the handle down slightly to work to the left.

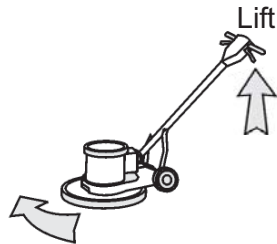
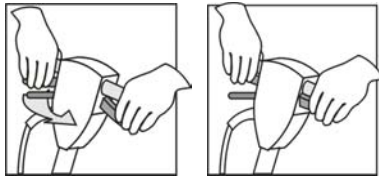
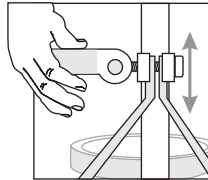

## 3.1 To store your machine

- Lock the handle in the “up” position. Tilt the machine back and remove the pad driver or brush.
- Wind the cord around the handles and the bottom cord hook.
- Wash brushes or pads and hang to dry.
- Never store machine standing on the brush.
- Inspect and maintain equipment on a regular schedule for best results.
  - ✓ Check and clean pads after each operation. Remove soil and chemical buildup. Replace worn or damaged pads.
  - ✓ Check the triggers and switches for proper operation.
  - ✓ Repair or replace damaged skirts and bumpers.
  - ✓ Use air pressure or vacuum to remove dust and debris from the motor vents.
  - ✓ Report any performance problems and repair promptly.

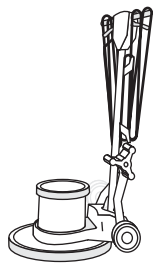
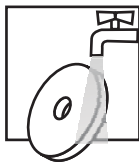

## 3.2 Transport

- To transport this floor machine from the janitors closet to the work area,
- Lock the handle in the “up” position. Wind the cord around the handles and the bottom cord hook.
- Tip the machine back onto the transport wheels. Push or pull the machine by the handle, not by the cord or any other part of the machine. Travel carefully.

## 4.0 Troubleshooting

Never operate this floor machine when the equipment is not performing as expected or when any part is visibly damaged. The cause and solution for some basic problems are described below. When repair is needed, take the equipment to an authorized repair service center.

### 4.1 Floor machine will not run

- Circuit breaker tripped in building. **Check and reset.**
- Equipment unplugged. **Check plug at wall and at machine base. Plug in.**
- Power cord failure. **Test with a working power cord. Lock the handle up and tip the motor back. Unplug the cord at the motor base and plug into a working power cord. IMPORTANT! When you do this, you have removed the safety handle controls from the circuit and you are sending power directly to the motor. If the motor spins, the problem is in the cord or the handle assembly. If the motor does not spin, the problem is in the motor. In either case, seek authorized repair service.**
- Motor sparks, smoke or other failure. **Seek authorized repair service.**

### 4.2 Electrical shock to operator

- Equipment wiring failure or electrical short in the machine. **Seek authorized service.**
- Poor grounding or no grounding. **Test the outlet with a ground fault interrupter device. Retain a certified electrician to inspect and repair grounding. NEVER clip off the ground plug on your cord.**
- Repeated circuit breaking. **High amp draw and circuit breaking can be an electrical or mechanical problem. Seek authorized repair service.**

### 4.3 High Vibration

- Pad not centered. **Tip machine back and re-center the pad.**
- Unevenly wear or warp to pad or brushes. **Replace.**
- Machine chassis damaged by dropping. **Replace.**

## 5.0 Brush and Pad Construction

Your new floor machine provides reliable, efficient, safe power to your scrubbing brush. To get the best results, you need to use a brush of the best design and construction.

### Basic Construction

Your floor machine is built with a “B” style **drive plug (1)**. The height and width of the ears on the plug will fit a “B” style or a “Universal” **clutch plate (2)**.

The **brush block (3)** is constructed of molded plastic or thick plywood. **Use a brush with a block diameter 2” less than the size of the machine apron size that you’re using.**

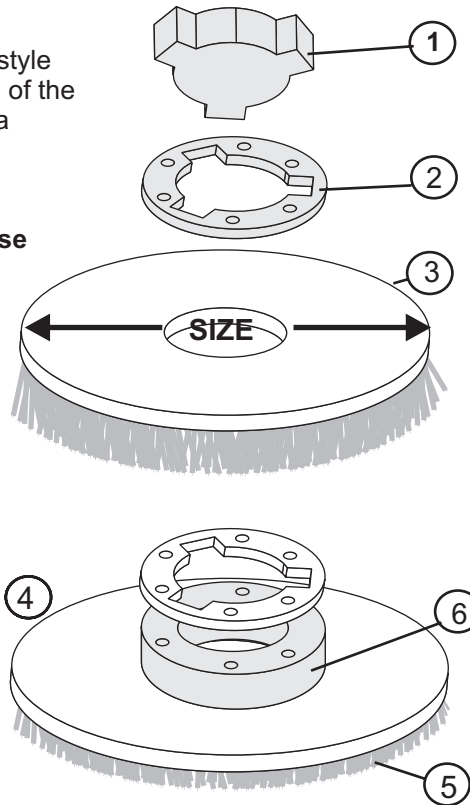

**Pad drivers (4)** typically have shorter, stiffer, pad-holding bristles (5) and use a riser (6) to create extra clearance between the block and the machine apron. With this construction, you can **use a pad driver with block diameter 1” less than the machine apron size that you’re using.**

Machine Apron Size	13”	15”	17”	19”	21”
Pad Driver - with 1” Riser	12”	14”	16”	18”	20”
Brush - with NO RISER	11”	13”	15”	17”	19”

The **bristle material (5)** that actually does the scrubbing is typically 1-1/2” to 2” long. When the bristle wears down to less than 1/2” long, the bristles have little flexibility and it’s time to replace.

The bristle materials are described on the next page.

## 5.1 Scrubbing Brush Filaments

Scrubbing brushes are available with a range of bristle types - - from the softest for the highest gloss floors, to the most aggressive for the heaviest soils. Match your brush to the floor as you match a detergent with the soils.

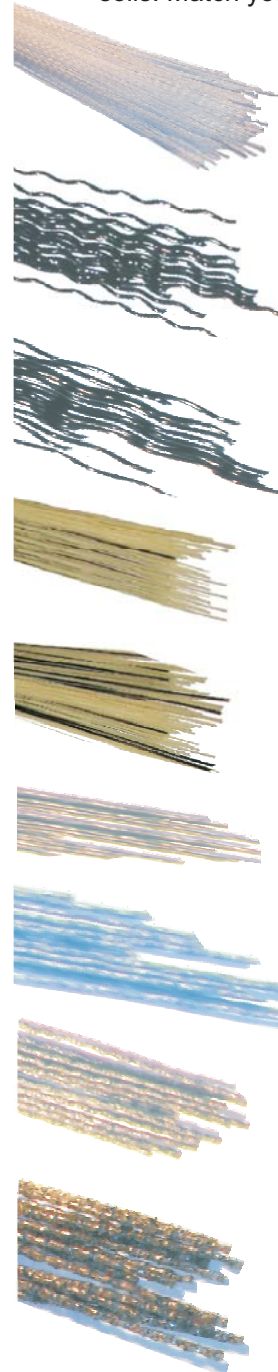

**Nylon** is used for gentle scrubbing in light soil. Because nylon softens when wet, it is used for gentle scrubbing, mopping and polishing of decorative floors. Nylon will not scratch tile, terrazzo or coated surfaces. Nylon brushes are durable and long lasting.

**Polypropylene** is the most common choice for general purpose scrubbing, and works well on both concrete and on coated floors. Polypropylene is lower cost than nylon, but does not last as long.

**Non-Scuff Poly** is a finer diameter (0.015-0.018”) filament used for lighter duty scrubbing conditions and on waxed or finished floors.

**Bassine** is a soft natural fiber. The end of the bristle splits or “flags” to build a buffing surface.

**Union Mix** is a mixture of Bassine and Tampico (another natural fiber). The mixture is stiffer than bassine alone and is used by more traditional cleaners for scrubbing.

**Soft Abrasive Bristle** is a 0.018 filament with 500 grade grit. As aggressive as a white scrub pad. For gentle scrubbing.

**Daily Abrasive Bristle** is a 0.035 filament with 180 grade grit. For daily scrubbing of resilient tile and finished floors. As aggressive as a red scrub pad.

**Stripper Abrasive Bristle** is a 0.022 filament with 120 grade grit. For aggressive scrubbing and light stripping of resilient floors, terrazzo and concrete. As aggressive as a blue scrub pad.

**Heavy Duty Stripper Abrasive Bristle** is a 0.050 filament with 80 grade grit. For very aggressive scrubbing and stripping of concrete, brick and quarry tile. As aggressive as a black pad.

# The BOSS 175/300

Heavy-Duty Floor Machine  
Interchangeable Aprons  
175 / 300 RPM Dual Speed  
13", 15" 17", 19" and 21" Aprons

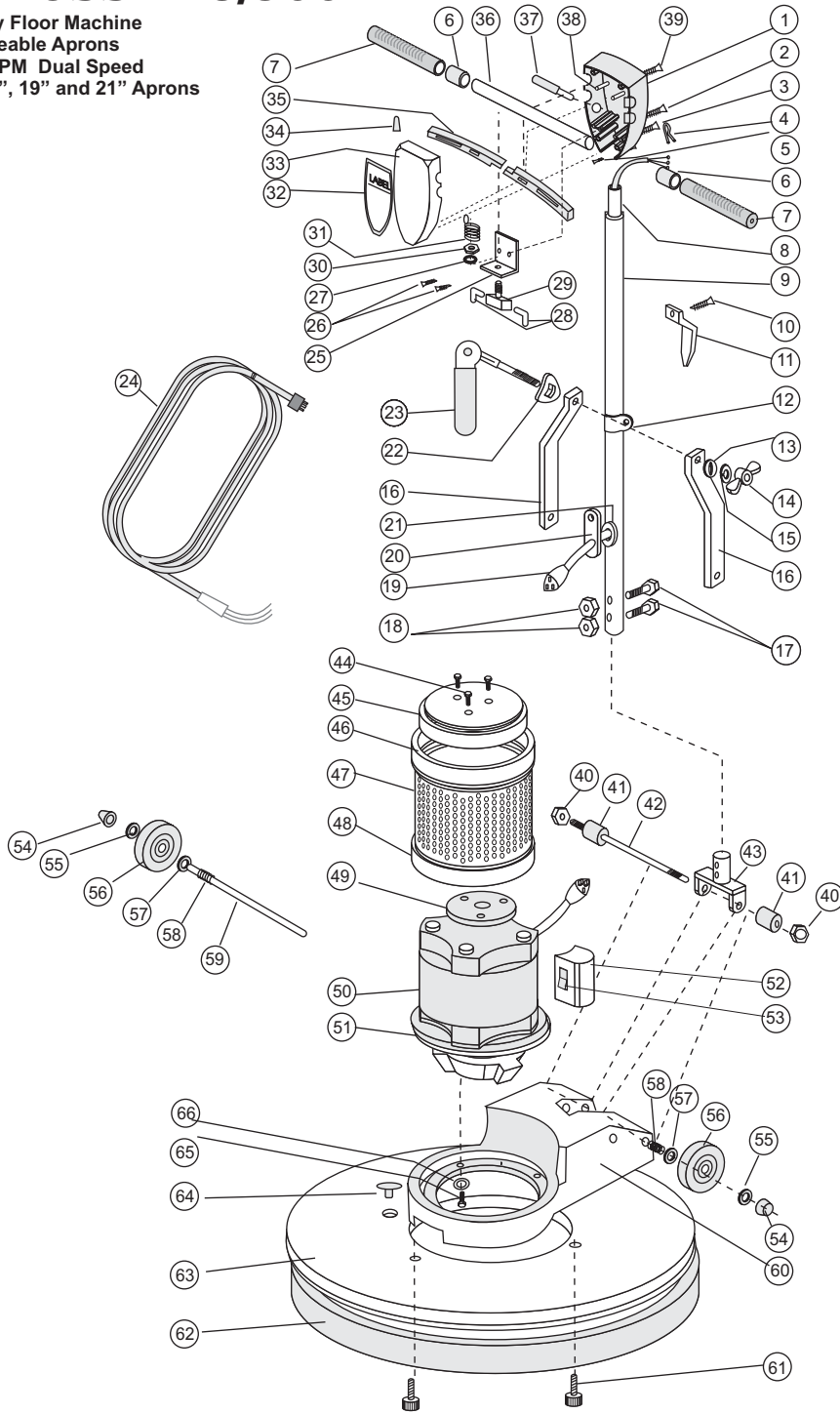

Number	Description	PART #	# Required
1	Switch Box Back	A-104	1
2	Handle Tube Screw	B-23	2
3	Switch Box Closing Screw	B-21	4
4	Strain Relief Clip	M-213	1
5	Ground Wire Screw	B-68	2
6	Rubber Spacer	M-218 Y	2
7	Hand Grip	M-218	2
8	Handle Tube Insert	M-247	1
9	Handle Tube Assembly	M-206	1
10	Cable Hook Screw	B-2	2
11	Cable Hook	A-164	1
12	Sliding Collar	A-111	1
13	Oval Hole Cam Washer	B-37	1
14	Cam Lock Wing Nut	B-25	1
15	Cam Split Washer	B-39	1
16	Bent Brace	M-216	2
17	Yoke Bolt	B-18A	2
18	Yoke Nut	B-19	2
19	Handle Tube Cable	G-16	1
20	Black Rubber Cable Connector	M-249	1
21	Cable Grommet	B-63	1
22	Rectangular Hole Cam Washer	B-67	1
23	Complete Cam Assembly	CCA	1
24	50 Foot Cable 14/3 Yellow	G-14-50-Y	1
25	Switch Mounting Plate	G-30-B	1
26	Switch Plate Screw	B-1	2
27	Int. Tooth Lock Washer (For Switch)	B-35	1
28	Insulated Flag Wire Connector	G-48	2
29	On-Off Switch And Plate Assembly	G-30-AB	1
30	Lock Washer	B-33	1
31	Trigger Return Spring	G-30-CT057	1
32	Label For Switch Box	CALL FOR #	1
33	Switch Box Front	A-103	1
34	Wire Connector	G-47	1
35	Trigger	A-105	2
36	16" Crossbar	M-211-A	1
37	Safety Interlock Assembly	SIA-1	1
38	Trigger Pin	B-70	2
39	Crossbar Screw	B-22	2
40	Acorn Nut For Yoke Pin	B-8	2
41	Rubber Yoke Spacer	B-5	2
42	Yoke Pin	B-7	1
43	Yoke	A-1001	1
44	Drip Cap Mounting Screw	B-151	3
45	66 Frame Drip Cap Cover	M-242	1
46	66 Frame Drip Cap Cover Bumper	M-239	1
47	Two-Speed Motor Screen	SCR-02	1
48	Two-Speed Motor Screen Bumper	M-238-1	1
49	Cork Drip Cap Gasket	M-248	1
50	Two-Speed D/C Motor, 66 Frame 1.5 HP With Gearbox	SRR-01	1
51	Gear Box, 11:1, Triple Planetary	GB96008	1
52	Two-Speed Hi-Lo Switch Box	SCAP-2	1
53	Two-Speed Hi-Lo Switch	HILO-TS	1
54	Hub Caps	V0038	2
55	Spring Washer	B-51	4
56	6" Wheels	M-250	2
57	1/2" Flat Washer	B-29	2
58	Spring	B-30	2
59	Axel	M-240	1
60	Main Machine Frame	A-166	1
61	Thumb Screw - Apron Mounting	B-96	3
62	Bumper 13"	M-232-13	1
62A	Bumper 15"	M-232-15	1
62B	Bumper 17"	M-232-17	1
62C	Bumper 19"	M-232-19	1
62D	Bumper 21"	M-232-21	1
63B	Apron 13"	A-173	1
63B	Apron 15"	A-167	1
63B	Apron 17"	A-169	1
63C	Apron 19"	A-171	1
63D	Apron 21"	A-172	1
64	Scrubber Plug	B-50	1
65	Base Casting Screw	B-95	3
66	1/4" Medium Split Washer	B-32	3

## Mercury Floor Machines, Inc New Equipment Warranty

### Limited Warranty

Mercury Floor Machines, Inc. warrants new equipment against defects in material and workmanship under normal use and service to the original purchaser. Any statutory implied warranties, including any warranty of merchantability or fitness for a particular purpose, are expressly limited to the duration of this written warranty. Mercury Floor Machines, Inc. will not be liable for any other damages, including but not limited to indirect or special consequential damages arising out of or in connection with the furnishing, performance, use or inability to use the machine. This remedy shall be the exclusive remedy of the purchaser. The warranty period is subject to the conditions stated below.

### 5 Years - Motor and Gearbox. 1 Year- Service Labor

Mercury Floor Machines Inc. warrants electric motors and transmission gearboxes on all Mercury floor machines to be free from defects in material and workmanship, under normal use and service for five (5) years to the original purchaser. Parts replaced or repaired under this warranty are warranted for the remainder of the original warranty period. Service labor charges are covered for up to one (1) year from the date of purchase through an authorized Mercury Floor Machine service provider. Travel expenses are NOT covered.

Normal wear items such as belts, brushes, bumpers, capacitors, carbon brushes, casters, clutches, cords, finishes, gaskets, rectifiers, switches, squeegees, bearings, pulleys, relays, actuating cables, wheels, and tires will be warranted for manufacturing defects for 90-days from the purchase date.

The warranty starts on the purchase date by the original purchaser from an authorized Mercury Floor Machine Distributor, subject to proof of purchase. The Machine Registration Card must be completed and returned immediately at the time of purchase. If proof of purchase cannot be identified, the warranty start date is 90 days after the date of sale to an authorized Mercury Floor Machine distributor.



©2003 Mercury Floor Machines, Inc.

110 South Van Brunt Street  
Englewood, NJ 07631  
Phone (201) 568-4606  
Toll Free (888) 568-4606  
FAX (201) 568-7962  
[www.mercuryfloormachines.com](http://www.mercuryfloormachines.com)

