

## COMMERCIAL UPRIGHT VACUUM CLEANER OWNER'S GUIDE SC785 SERIES

### Index

Important Safeguards.....	2
General Information .....	6
Use .....	7-8
Accessories .....	9
Dust Bag .....	10
Filters .....	11
Brush Roll .....	12
Brush Roll Belt .....	12
Warranty .....	15

For location of nearest  
Eureka/Sanitaire Warranty Station  
or service information call  
1-800-282-2886.

[www.eureka.com](http://www.eureka.com)

# IMPORTANT SAFEGUARDS

When using an electrical appliance, basic precautions should always be followed, including the following:

**READ ALL INSTRUCTIONS BEFORE USING THIS VACUUM CLEANER.**

## WARNING

To reduce the risk of fire, electric shock, or injury:

- Do not use outdoors or on wet surfaces.
- Do not leave vacuum cleaner when plugged in. Turn off the switch and unplug the electrical cord when not in use and before servicing.
- Do not allow to be used as a toy. Close attention is necessary when used by or near children.
- Use only as described in this manual. Use only manufacturer's recommended attachments.
- Do not use with damaged cord or plug. If vacuum cleaner is not working as it should, has been dropped, damaged, left outdoors, or dropped into water, return it to a service center before using.
- Do not pull or carry by cord, use cord as a handle, close door on cord, or pull cord around sharp edges or corners. Do not run vacuum cleaner over cord. Keep cord away from heated surfaces.
- Connect to a properly grounded outlet only (refer to Grounding Instructions).
- Do not use extension cords or outlets with inadequate current carrying capacity.
- Turn off all controls before unplugging.
- Do not unplug by pulling on cord. To unplug, grasp the plug, not the cord.
- Do not handle plug or vacuum cleaner with wet hands.
- Do not put any object into openings. Do not use with any opening blocked; keep free of dust, lint, hair, and anything that may reduce airflow.
- This vacuum cleaner creates suction and contains a revolving brush roll. Keep hair, loose clothing, fingers, and all parts of body away from openings and moving parts.
- Do not pick up anything that is burning or smoking, such as cigarettes, matches, or hot ashes.
- Do not use without dust bag in place.
- Belt pulleys can become hot during normal use. To prevent burns, avoid touching the belt pulley when servicing the drive belt.
- Use extra care when cleaning on stairs.
- Do not use to pick up flammable or combustible liquids such as gasoline, or use in areas where they may be present.
- Store your cleaner indoors in a cool, dry area.
- Keep your work area well lighted.
- Unplug electrical appliances before vacuuming them.

## SAVE THESE INSTRUCTIONS

# Grounding Instructions

This appliance must be grounded. If it should malfunction or breakdown, grounding provides a path of least resistance for electric current to reduce the risk of electric shock. This appliance is equipped with a cord having an equipment-grounding conductor and grounding plug. The plug must be plugged into an appropriate outlet that is properly installed and grounded in accordance with all local codes and ordinances.

## DANGER

Improper connection of an equipment-grounding conductor can result in risk of electric shock. Check with a qualified electrician or service person if you are in doubt as to whether the outlet is properly grounded. Do not modify the plug provided with the appliance. If it will not fit the outlet, have proper outlet installed by a qualified technician.

This appliance is for use on a nominal 120 volt circuit and has a grounding plug that looks like the plug illustrated in Figure A. A temporary adapter which looks like the adapter illustrated in Figure B may be used to connect this plug to a two-pole receptacle, as shown, if a properly grounded outlet is not available. The temporary adapter should be used only until a properly grounded outlet, Figure A, can be installed by a qualified electrician. The green colored rigid ear, lug, or the like extending from the adapter must be connected to a permanent ground such as a properly grounded outlet box cover. Whenever the adapter is used, it must be held in place by a metal screw.

**NOTE:** In Canada, the use of a temporary adapter is not permitted by the Canadian Electrical Code.

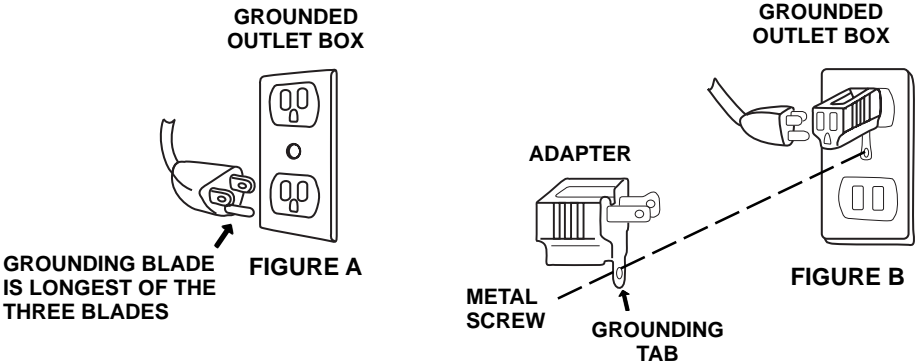

# CONSEILS DE SÉCURITÉ

Lors de l'utilisation d'un appareil électrique, quelques précautions élémentaires doivent être observées, incluant les suivantes:

**LISEZ TOUTES LES INSTRUCTIONS AVANT D'UTILISER VOTRE ASPIRATEUR.**

## AVERTISSEMENT

Pour réduire le risque de feu, de choc électrique, ou de blessure:

- Ne pas utiliser à l'extérieur ou sur des surfaces mouillées.
- Fermez le commutateur et débranchez l'appareil lorsque vous ne l'utilisez pas ou avant le nettoyage ou l'entretien.
- Ne permettez pas qu'il soit utilisé comme jouet. Une attention particulière est nécessaire lorsque utilisé par ou près d'un enfant.
- Suivez les recommandations d'utilisation de ce manuel. Utilisez uniquement les accessoires recommandés par le fabricant.
- Ne pas utiliser si le cordon ou la fiche sont endommagés. Si l'aspirateur ne fonctionne pas comme il le devrait, s'il a été échappé, s'il est endommagé, s'il a été laissé à l'extérieur ou échappé dans l'eau, retournez-le à un centre de service avant de utiliser.
- Ne pas le tirer ou le transporter par le cordon, ne pas utiliser le cordon en guise de poignée. Ne pas fermer une porte sur le cordon ou tirer le cordon sur des coins ou bordures pointus. Ne pas circuler sur le cordon avec l'aspirateur. Tenir le cordon à distance des surfaces chauffantes.
- Branchez toujours l'aspirateur dans une prise à trois (mise à la terre).
- Ne pas utiliser des rallonges ou des prises qui n'ont pas de capacité suffisante pour transporter le courant.
- Fermer tous les contrôles avant débrancher.
- Ne pas débrancher en tirant sur le cordon. Pour débrancher, tenez la fiche et non le cordon.
- Ne pas manipuler la fiche ou l'aspirateur avec les mains mouillées.
- Ne pas rien insérer dans les ouvertures. Ne pas utiliser si des ouvertures sont bloquées; assurez-vous qu'elles soient dégagées de poussière, mousse, cheveux ou toute autre chose qui pourrait réduire le passage de l'air.
- Cet aspirateur créé de la succion et contient un rouleau-brosse tournant. Tenir les parties mobiles et les ouvertures loin des cheveux, du linge, des doigts et de toute partie du corps.
- Ne pas ramasser des objets qui brûlent ou fument comme les cigarettes, allumettes ou cendres chaudes.
- N'utilisez pas sans le sac de poussière en place.
- Les poulies du courroie peuvent devenir chaudes pendant l'utilisation normale. Pour prévenir des brûlures, évitez de touché la poulie du courroie lorsque vous réparez la courroie.
- Portez une attention particulière lorsque vous nettoyez les escaliers.
- Ne pas utiliser pour ramasser des liquides inflammables ou combustibles comme de l'essence: Ne pas utiliser dans les endroits où ces liquides pourraient être présents.
- Entrez votre aspirateur à l'intérieur dans un endroit propre et sec.
- Maintenez un bon éclairage à l'endroit où vous travaillez.
- Débrancher les appareils électrique avant de les balayer.

## CONSERVEZ CES INSTRUCTIONS

# INSTRUCTIONS VISANT LA MISE À LA TERRE

Cet appareil doit être mis à la terre. En cas de défaillance ou de panne éventuelles, la mise à la terre fournit au courant un chemin de moindre résistance qui réduit le risque de choc électrique. Cet appareil est pourvu d'un cordon muni d'un conducteur de terre et d'une fiche avec broche de terre. La fiche doit être branchée dans une prise appropriée correctement installée et mise à la terre conformément aux règlements et ordonnances municipaux.

## AVERTISSEMENT

Un conducteur de terre mal raccordé peut entraîner un risque de choc électrique. Consulter un électricien ou un technicien d'entretien qualifié si vous n'êtes pas certain que la prise est correctement mise à la terre. Ne pas modifier la fiche fournie avec l'appareil-si elle ne peut être insérée dans la prise, faire installer une prise adéquate par un électricien qualifié.

**Note:** Au Canada, l'utilisation d'un adaptateur temporaire n'est pas autorisée par le Code canadien de l'électricité.

Cet appareil est destiné à un circuit de 120 V et est muni d'une fiche de mise à la terre semblable à celle illustrée par le Figure A. S'assurer que l'appareil est branché à une prise de courant ayant la même configuration que la fiche. Aucun adaptateur ne devrait être utilisé avec cet appareil.

### Boîte de Prise de Terre

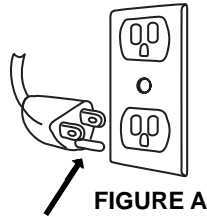

LA LAME DE TERRE  
EST LA PLUS LONGUE  
DES TROIS LAMES

## GENERAL INFORMATION

The cleaner is designed to pick up dirt and dust particles. Avoid picking up hard or sharp objects with the cleaner to prevent bag tears and hose clogs.

## Service Information

The instructions in this booklet serve as a guide to routine maintenance. For additional service information telephone our toll free number for the nearest Eureka/Sanitaire Authorized Warranty Station. Refer to The Sanitaire Commercial Warranty for complete service information. **You should know the model, type and serial numbers when you call:**

**USA: 1-800-282-2886**  
**Mexico: 5670-6169**  
**Canada: 1-800-282-2886**



**DO NOT OIL the motor or the brush roll at any time. The bearings are permanently lubricated and sealed.**

## Rating Plate

The model, type, and serial number are indicated on the rating plate located on the back of the cleaner. For prompt and complete service information, always refer to these numbers when inquiring about service.

MODEL	TYPE	SERIAL NO.
VOLTS	AMPS.	HERTZ
SERVICE INFORMATION: 1-800-282-2886		

**Model & Type** \_\_\_\_\_

**Serial No.** \_\_\_\_\_

## Cleaner Care

**NOTE: Turn off the switch and unplug the electrical cord before cleaning unit.**

To keep the vacuum cleaner looking new, it can be wiped with a damp cloth and a mild soap solution, then thoroughly dried. Never use any type of chemical as chemicals can damage the cleaner. When not in use, the cleaner should be stored in a clean, dry place.

# HOW TO USE

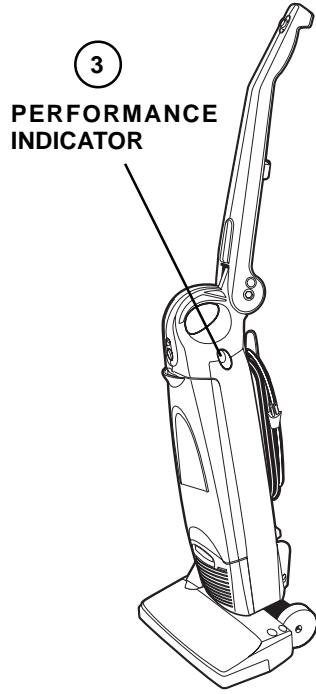
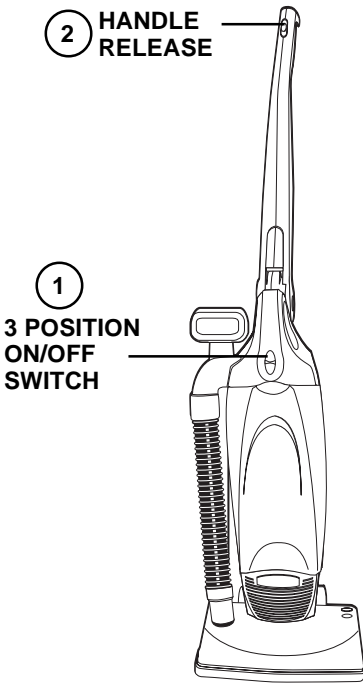

## 1 Power Switch

Top position is Off. Middle position is for floor cleaning and cleaning with accessories (brush roll does not turn). Bottom position is for cleaning carpets (brush roll turns).

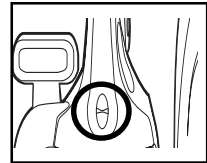

## 2 Handle Release

When handle is in collapsed position, press handle release button and rotate handle into upright position.

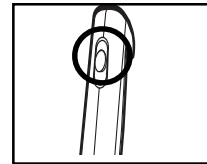

## 3 Performance Indicator

The performance indicator light will come on when there is a drop in the vacuums performance. Check for a full dust bag, dirty filters or a clog in the brush roll or hose areas. If a full bag, dirty filter or clogged brush roll/hose is found, replace the bag, clean or replace the filters, or unclog the brush roll/hose areas.

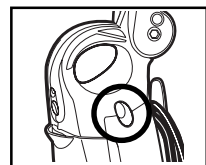

# HOW TO USE

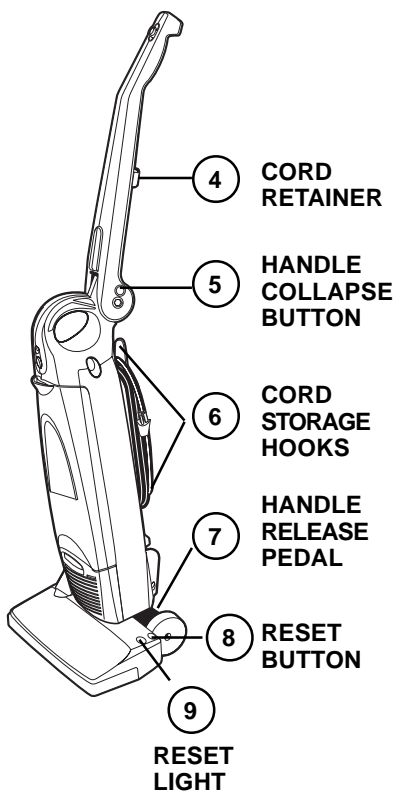

## 4 Cord Retainer

When preparing to use vacuum, firmly push the electrical cord down into the cord retainer. This will place the electrical cord out of the way while you vacuum.



## 5 Handle Collapse Button

To collapse the handle from the upright position, press handle collapse button, rotate handle down until latch in hand grip locks onto the body.

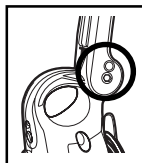

## 6 Cord Storage Hooks

This unit has two convenient cord storage hooks attached to the handle. Wind the cord around the hooks and fasten the plug to the cord to prevent unwinding.

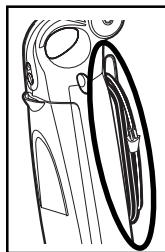

## 7 Handle Release Pedal

The handle release pedal is located next to the floor between the two wheels on the back of the cleaner. Step on the handle release pedal and pull back handle to find a comfortable operating position. Handle will automatically lock into storage position when handle is rotated into upright position.

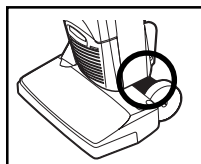

## 8 Reset Button

This unit uses a cogged, non-stretch belt. If a large object causes the brush roll to jam, the brush roll motor shuts off and the Reset Light illuminates. Turn off and unplug the unit. Check the brush roll for debris and clean if needed. Press the reset button, plug in the unit and turn on to continue cleaning.

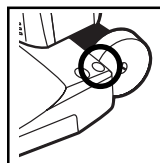

## 9 Reset Light

The reset light is a LED light that illuminates when the brush roll jams. See reset button above for actions to take when this light comes on.

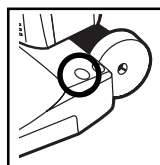



# HOW TO USE ACCESSORIES

3  
Dusting Brush

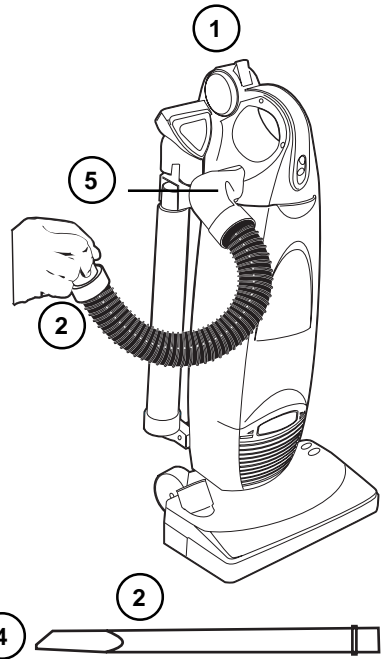

1 Collapse the handle from the upright position. Press handle release button and rotate handle down and against the body of the cleaner until it locks onto the body.

2 The dusting brush and upholstery nozzle fit on both the hose and the wand with a built-in crevice tool.

3 Use the dusting brush to dust furniture, blinds, books, lamps, shelves.

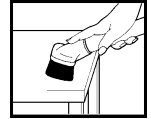

4 The crevice tool cleans corners, base boards, between cushions.

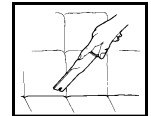

5 Hose elbow rotates for easy use of the hose and attachments.



To disconnect hose for inspection of blockages, align notch on top of elbow with arrow on main body. Check for blockages and clear if necessary. Align notch on top of elbow with arrow on main body to reconnect.

## HOW TO MAINTAIN

The instructions given in this booklet serve as a guide to routine maintenance. To avoid unnecessary service calls, check the bag, belt, and brush roll often. Change the bag if it is full; replace the belt if it is stretched or cracked, and clean the brush roll bristles if they are wrapped with thread and hair.

### DUST BAG (Style SL)

The dust bag plays a very important role in the efficiency of the vacuum cleaner. The bag traps the dirt and allows the air to pass through. If the bag becomes clogged, no air can pass through the cleaner and no cleaning can take place, regardless of how powerful the unit is. To keep the cleaner operating at maximum efficiency, change the dust bag frequently. Some fine particles can restrict air flow very quickly and will decrease performance even before the bag appears to be full. For that reason, when vacuuming carpet fresheners or cleaners, powder, plaster dust, or similar fine substances, the bag may need to be changed more often.

**NOTE: Turn off the switch and unplug the electrical cord before servicing the bag. Never operate the vacuum cleaner without the dust bag.**

**NOTE: When cleaning new carpet for the first time, bag will fill quickly. Check often.**

#### 1 Remove Front Cover

Grasp the handle at the top of the front cover. Pull out and up to remove from the unit.

#### 2 Remove Used Disposable Dust Bag

To release used bag, push top of bag retainer latch on inside of bag compartment and pull used bag down and out.

#### 3 Install New Disposable Dust Bag

Find bag rails on the inside of the bag compartment. Locate and position the bag collar (notch toward front) on bag rails. Push bag collar allowing it to follow the rails up inside the bag compartment. Push bag release button, lock bag collar up into bag release. Release button. The bag is held.

#### 4 Replace Front Cover

Place tabs on bottom of front cover into slots at the bottom of the bag compartment. Push up and against the body of cleaner until it snaps into place.

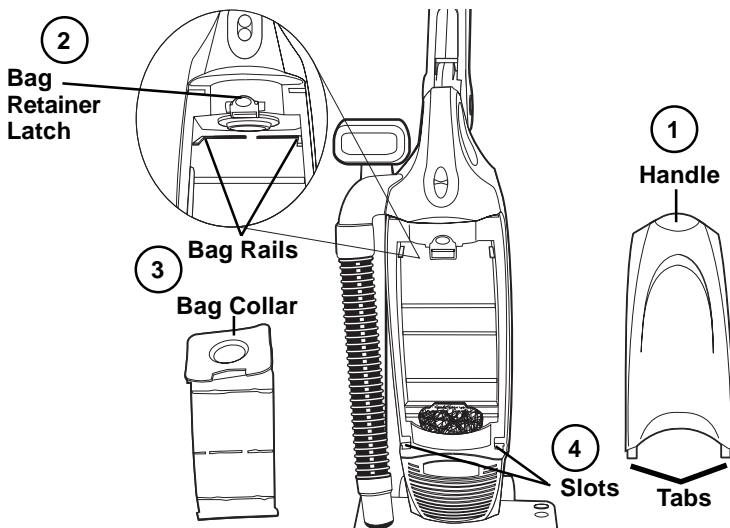

# HOW TO MAINTAIN (continued)

**NOTE:** Turn off the switch and unplug the electrical cord before servicing the cleaner. Never operate the vacuum cleaner without the dust bag or filters.

## FILTERS

The filters should be checked at each disposable dust bag change. If the filters are dirty, clean or replace for maximum performance of your cleaner.

### 1 Motor Filter

The motor filter is located below the dust bag inside the bag compartment. Remove the front cover. Take the dust bag out to check the motor filter. If the motor filter is dirty, remove and clean or replace with a new filter.

To clean the motor filter, brush the debris off into a trash bin or vacuum with another vacuum cleaner.

### 2 Exhaust Filter

The exhaust filter is located behind the dust filter grille below the bag compartment.

Remove the front cover. (The front cover has to be removed first to enable removal of exhaust grille.) Lift up on exhaust grille handle to remove. The filter is attached to the back of the grille. If the exhaust filter is dirty, remove and clean or replace with a new filter.

To clean the exhaust filter, brush the debris off into a trash bin or vacuum with another vacuum cleaner.

To replace the exhaust filter, tuck the bottom of the filter behind the two filter retainers at the bottom of the exhaust grille. Then place the top of the filter behind the two filter retainers at the top of the grille. Press the filter down on narrow pegs in the center of the grille. Replace the grille on the cleaner and replace the front cover.

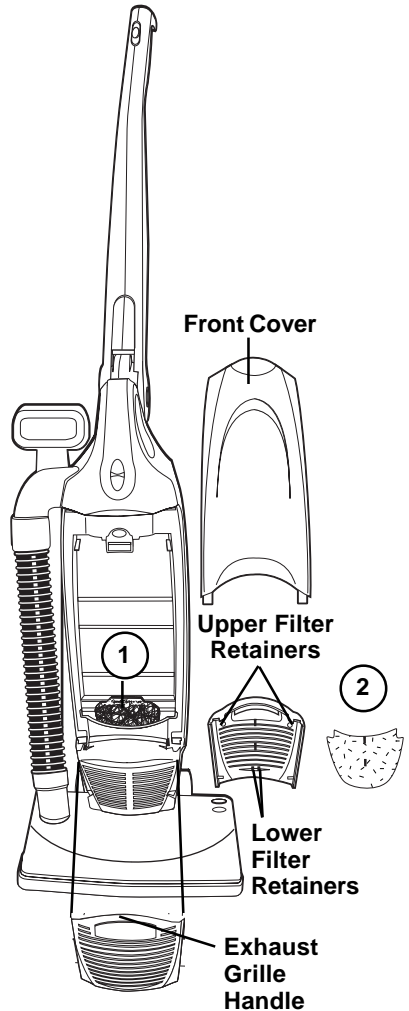

Look for the **GENUINE** symbol.  
EUREKA PRODUCT

## HOW TO MAINTAIN (continued)

**NOTE:** Turn off the switch and unplug the electrical cord before servicing the cleaner.

### REPLACE BRUSH ROLL BELT

① Remove the 10 screws on the bottom of the power nozzle. Flip the power nozzle back upright and remove the hood.

**NOTE:** The reset button cover (circled) is spring loaded so it may become displaced when you remove the hood. Keep track of reset button and spring.

② Remove broken brush roll belt. Pinch new brush roll belt together and position new belt so teeth engage cog pulley on end of motor shaft.

③ Place the other end of belt around brush roll. Align left end of brush roll into the base by rotating slightly until brush roll end cap slides into place.

Secure right end of brush roll into base.

④ The brush roll belt is now installed.

⑤ **Make sure the reset button cover (circled) is in position on spring.** Replace hood. Hold body and power nozzle, turn over so bottom of power nozzle is facing up. Replace screws.

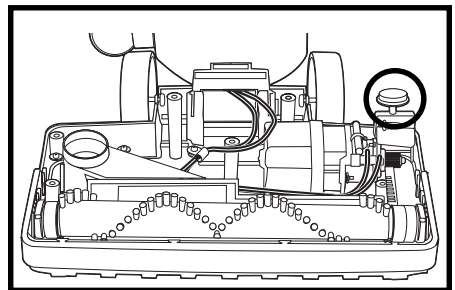
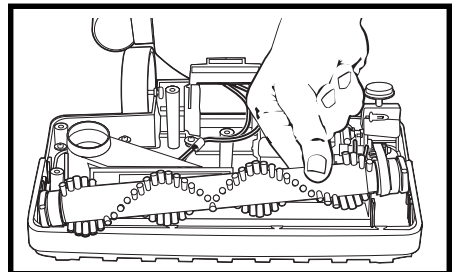
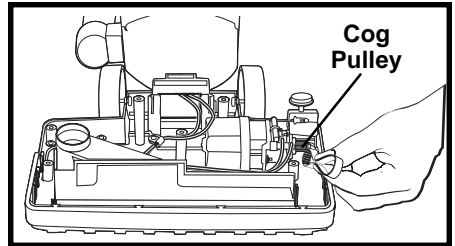
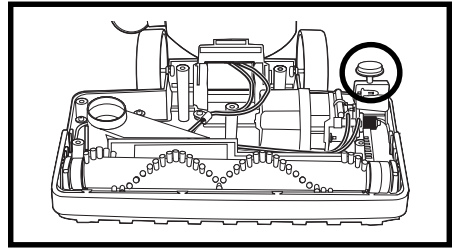

### Brush Roll

As the brush roll rotates, it sweeps and combs the carpet nap. Remove hair and threads from the brush roll so it continues brushing the carpet nap. Check brush roll occasionally for hair or string that may have wrapped around dowel. Remove with scissors.

When bristles have worn to about 1/4" in length, carpet cleaning effectiveness will be reduced. It is time to replace the brush roll. Follow the instructions in the brush roll belt section to open up the power nozzle and replace the brush roll.





## **THE SANITAIRE® COMMERCIAL LIMITED WARRANTY**

### **WHAT THIS WARRANTY COVERS**

Your Sanitaire commercial cleaner is warranted to be free from all defects in material and workmanship in normal use FOR A PERIOD OF ONE YEAR. The warranty is granted only to the original purchase of the cleaner. The warranty is subject to the following provisions.

### **WHAT THIS WARRANTY DOES NOT COVER**

- Parts of the cleaner that require replacement under normal use, such as bumpers, bags, bristle strips, belts, light bulbs, hoses, and impellers.
- Damages or malfunctions caused by negligence, abuse, or use not in accordance with the Owner's Guide.
- Defects or damages caused by unauthorized service or the use of other than Genuine Eureka parts.

### **WHAT THE EUREKA COMPANY WILL DO**

The Eureka Company will, at its option, repair or replace a defective cleaner or cleaner part that is covered by this warranty. As a matter of warranty policy, the Eureka Company will not refund the consumer's purchase price.

### **WARRANTY REGISTRATION**

Please fill out and return the warranty registration card accompanying your cleaner.

—continued on reverse side—

## OBTAINING WARRANTY SERVICE

To obtain warranty service you must return the defective cleaner or cleaner part along with proof of purchase to any Eureka/Sanitaire Authorized Warranty Station. You will find the nearest location in the Yellow Pages under "Vacuum Cleaners—Service and Repair." Be certain that the Warranty Station is "Eureka/Sanitaire Authorized."

For the location of the nearest Eureka/Sanitaire Authorized Warranty Station or for service information, telephone toll free:

**USA: 1-800-282-2886**

**Mexico: 5670-6169**

**Canada: 1-800-282-2886**

If you prefer, you can write to:

**The Eureka Company**

Service Division

807 North Main Street

Bloomington, IL 61701, USA

In Canada write to:

**The Eureka Company**

866 Langs Drive

Cambridge, Ontario N3H 2N7

If it is necessary to ship the cleaner outside your community to obtain warranty repair, you must pay the shipping charges to the Eureka/Sanitaire Authorized Warranty Station. Return shipping charges will be paid by the Warranty Station. When returning parts for repair, please include the model, type, and serial numbers from the data plate on the cleaner.

## FURTHER LIMITATIONS AND EXCLUSIONS

Any warranty that may be implied in connection with your purchase or use of the cleaner, including any warranty of MERCHANTABILITY or any warranty for FITNESS FOR A PARTICULAR PURPOSE is limited to the duration of this warranty. Some states do not allow limitations on how long an implied warranty lasts, so the above limitations may not apply to you.

Your relief for the breach of this warranty is limited to the relief expressly provided above. IN NO EVENT SHALL EUREKA BE LIABLE FOR ANY CONSEQUENTIAL OR INCIDENTAL DAMAGES THAT YOU MAY INCUR IN CONNECTION WITH YOUR PURCHASE OR USE OF THE CLEANER. Some states do not allow the exclusion or limitation of incidental or consequential damages, so the above limitation or exclusion may not apply to you.

This warranty gives you specific legal rights. You may also have other rights which vary by State.



**THE EUREKA COMPANY**

Bloomington, Illinois 61701

©1999 White Consolidated Ind., Inc.

Printed in China

Part No. 70733 (1/01)